

Two-Way Power Splitter 2.1–2.3 GHz



PD22-73

Features

- Low Cost
- Low Profile
- Small SOT-6 Package
- Tape & Reel

Description

The PD22-73 is a 50 Ω, in-phase combiner/splitter tuned for the 2.1–2.3 GHz band. The monolithic circuitry is 100% passive and offers low loss, high isolation and exceptional phase/amplitude balance. It is available in the SOT-6 leaded surface mount package.

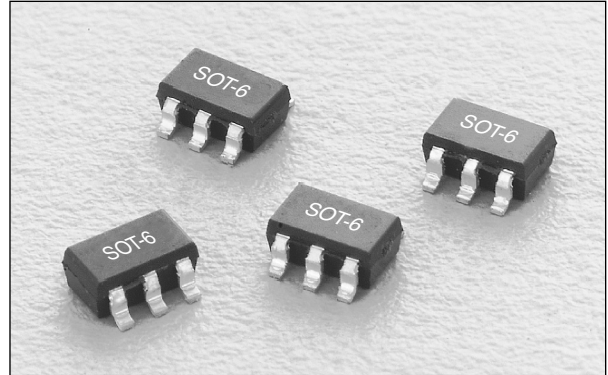

Electrical Specifications at 25°C, 50 Ω System

Parameter	Min.	Typ.	Max.	Unit
Frequency	2.1		2.3	GHz
Insertion Loss Less 3 dB Split		0.55	0.7	dB
Isolation ¹	15.0	18.00		dB
Input VSWR		1.5:1	2.0:1	
Output VSWR		1.1:1	1.3:1	
Amplitude Balance		±0.10	±0.2	dB
Phase Balance		±1.00	±3.0	Deg.

¹ Isolation can be increased to 23 dB with an external 5.6 nH inductor from in/sum port to ground.

Pin Out

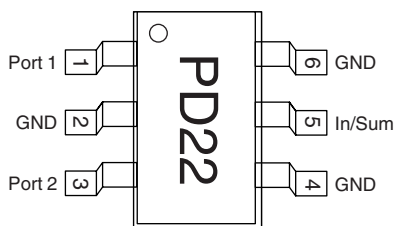

PD22 is the part marking.

Block Diagram

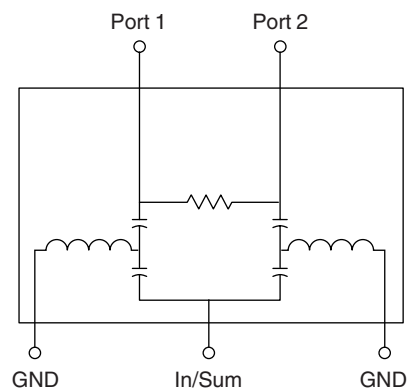

Typical Performance Data

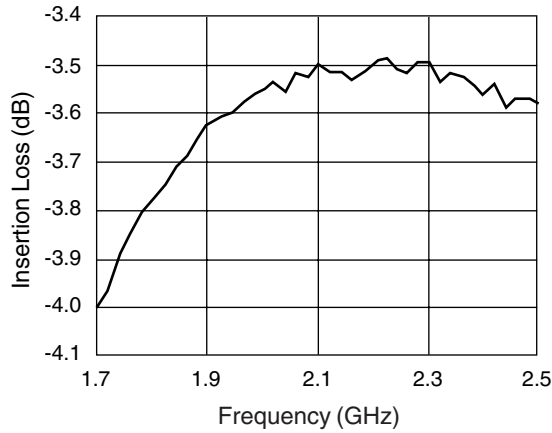

Insertion Loss vs. Frequency

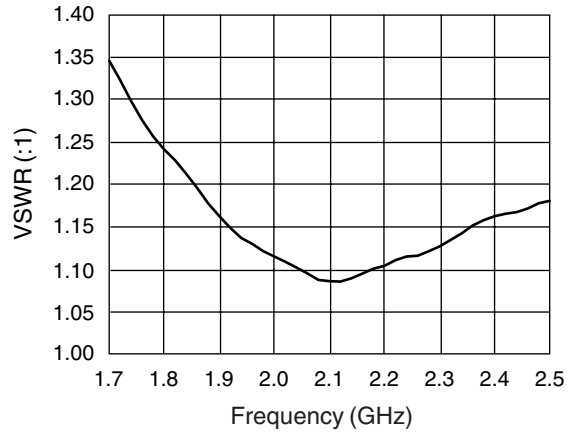

Output VSWR vs. Frequency

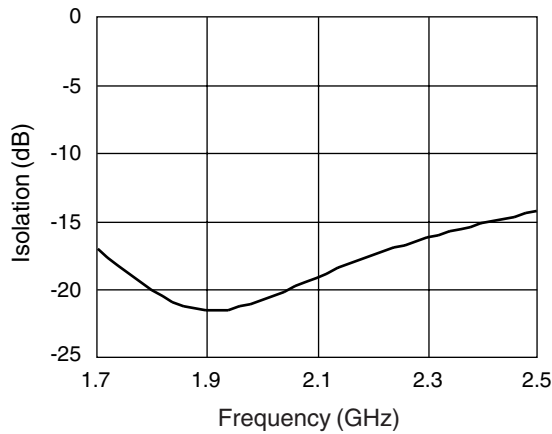

Isolation vs. Frequency

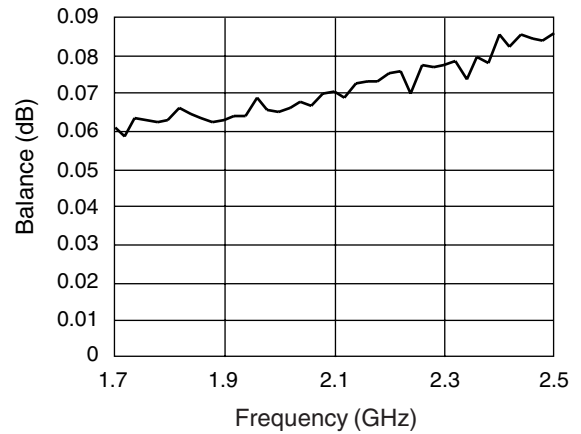

Amplitude Balance vs. Frequency

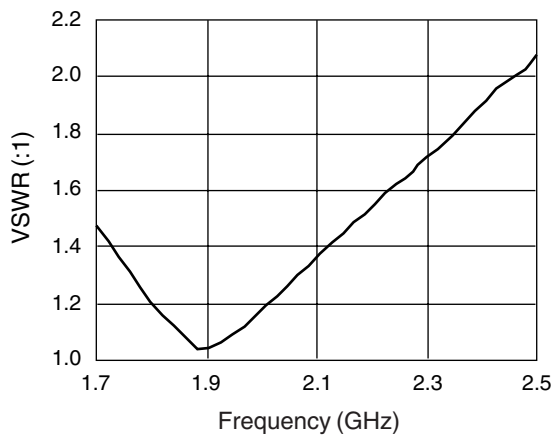

Input VSWR vs. Frequency

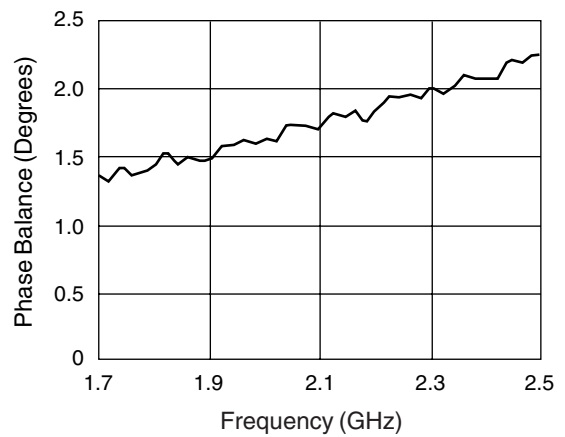

Phase Balance vs. Frequency

SOT-6

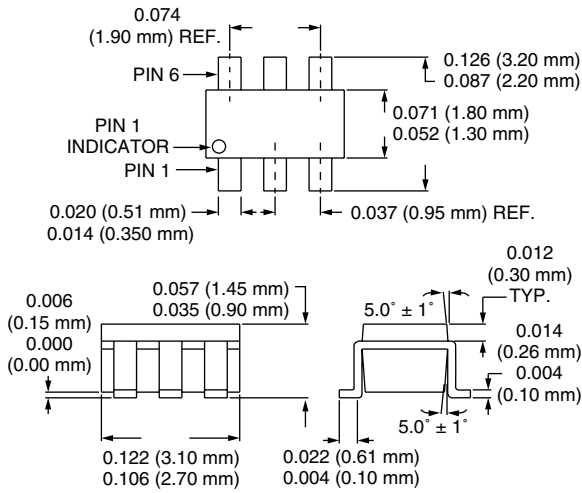

Absolute Maximum Ratings

Characteristic	Value
Input Power ¹	1.5 W CW
Input Power ²	0.75 W CW
Operating Temperature	-40°C to +85°C
Storage Temperature	-65°C to +150°C

1. When used as a power divider with a 2.0:1 maximum VSWR on all ports.
 2. When used as a power combiner with a 2.0:1 maximum VSWR on all ports.

Recommended Board Layout

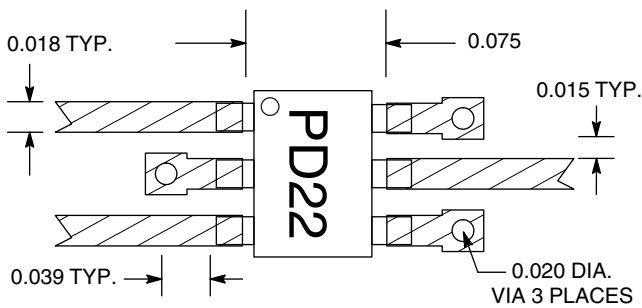

Material is 10 mil FR4